

**Den variable avskjerming  
Type 0455 + fargekode**

Effektiv flate  
h182cm x c/c 180cm = 3,30m<sup>2</sup>

Leveres flatpakket:  
12 WPC veggelementer  
topplist, sideskiner  
og skruer.

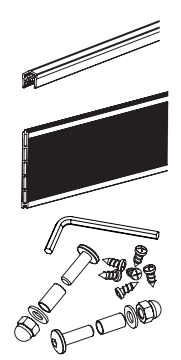

**Den variable avskjerming  
Type 0456 + fargekode**

Effektiv flate  
h92cm x c/c 180cm = 1,65m<sup>2</sup>

Leveres flatpakket:  
6 WPC veggelementer  
topplist, sideskiner  
og skruer.

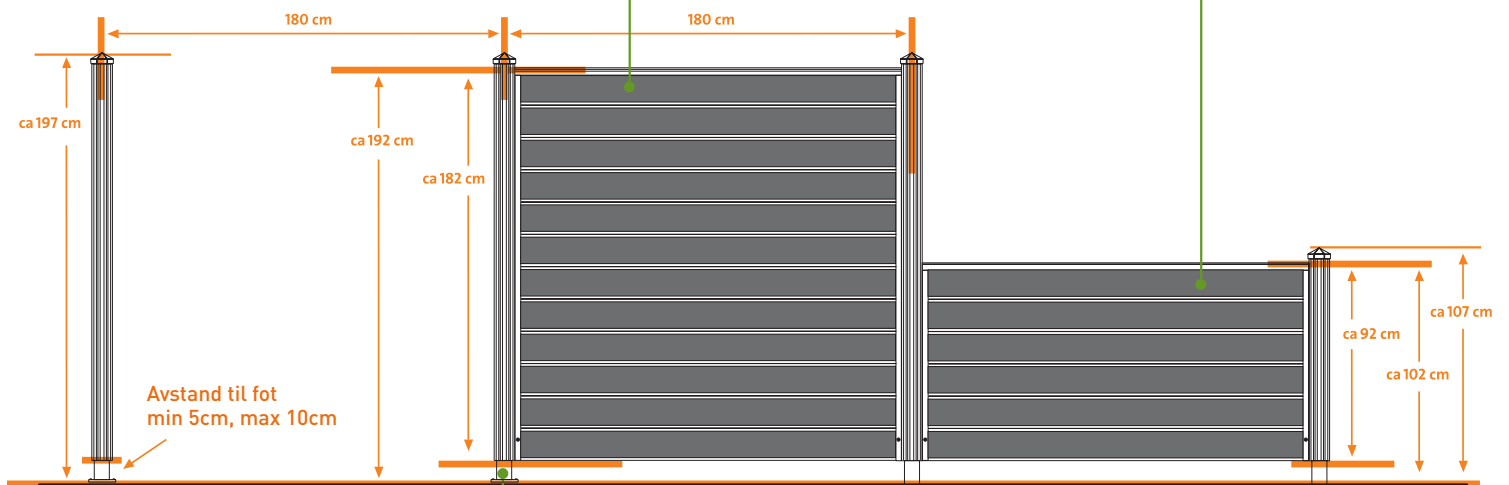

Fast grunn (Terrasse i betong, WPC eller tre)

ca 30-40cm i betong

ca 30-40cm i betong

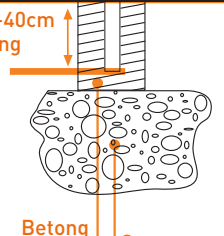
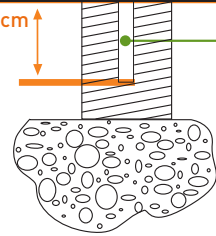

Betong  
Grus og sand ca 20cm

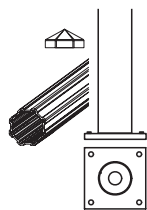

**Stolpe m/fot**  
14x14 + WPC hylster og lokk  
Type 0465 - 190 cm  
Type 0466 - 100 cm

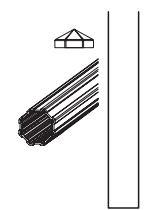

**Stolpe for innstøpning + WPC hylster og lokk**  
Type 0463 - 230 cm  
Type 0464 - 135 cm  
Forskallingsrør type 0500 - d20 x h50cm

**WPC veggelementer m/topplist.**  
Veggelementer og topplist må monteres med not ned.

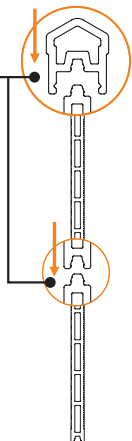

**Innfestning**  
Sideskinne skrues til stolpen gjennom hylster. Første/nederste vegg-element låses med bolter (2 stk) gjennom sideskinnene.

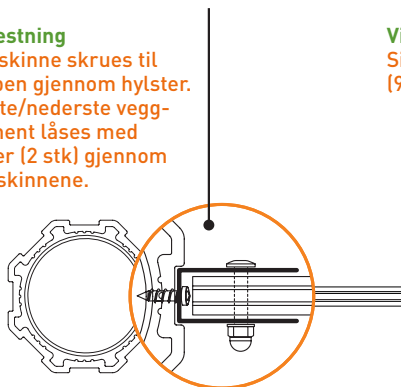

**Vinkler**  
Sideskinnen kan monteres i 8 stillinger (90 og 45 grader) rundt stolpen.

